

**15.11** T - nut  
**NPM**

SEND THE INQUIRY

+48 58 55 40 410

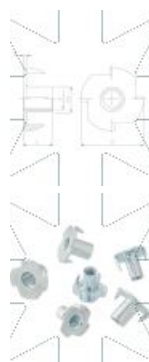
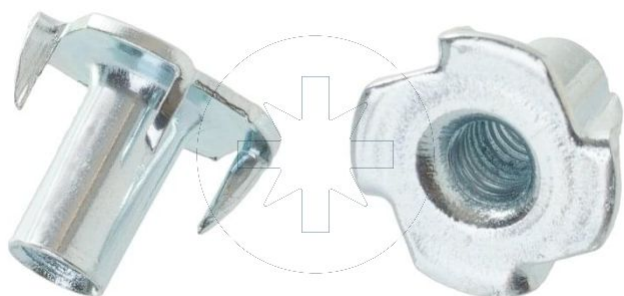

Coating (standard):

**B**

WHITE  
ZINC  
COATING

Coating (special order):

**A**

YELLOW  
ZINC  
COATING

**C**

BLACK  
ZINC  
COATING

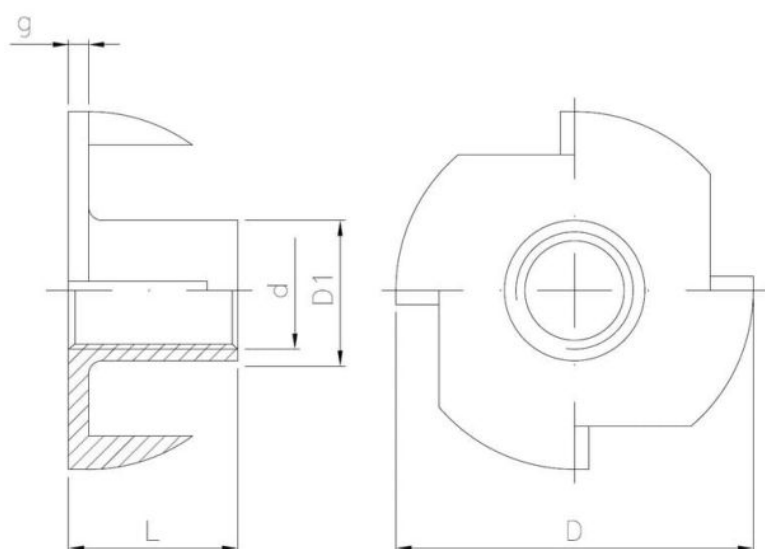

Dimensions

Material index	d	L [mm]	D [mm]	D1 [mm]	g [mm]	Type of coating
1511060009BT	M6	9.0	19.0	7.5	1.3	B (White zinc coating)