

15.01
N6K

Hexagon nuts

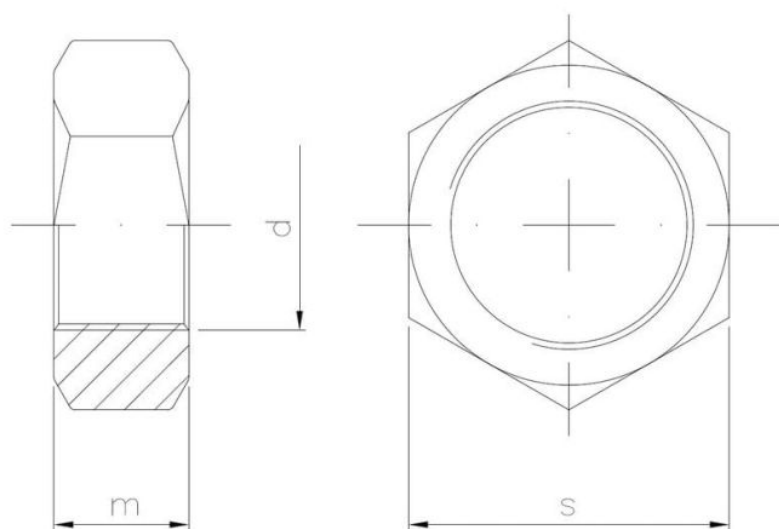
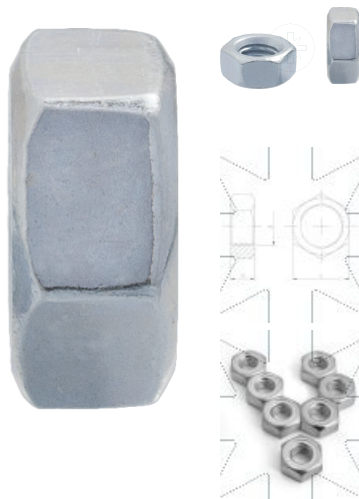
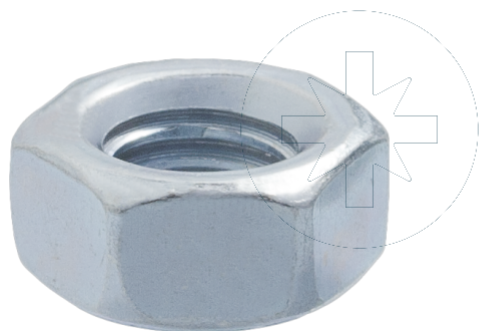

SEND THE INQUIRY

+48 58 55 40 410

Standards:

DIN 934
~ISO 4032
PN-M 82144

Class (standard):



Coating (standard):



Coating (special order):

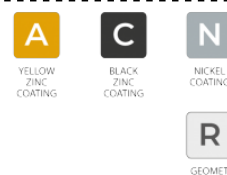

Dimensions

Material index	d	m [mm]	s [mm]	Mechanical properties class	Type of coating
1501030BD934T	M3	2.4	5.5	6	B (White zinc coating)