

15.01  
N6K

# Hexagon nuts

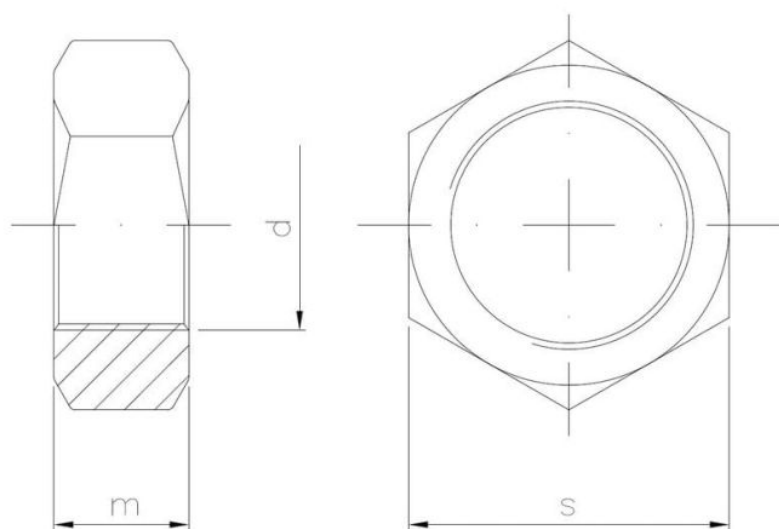
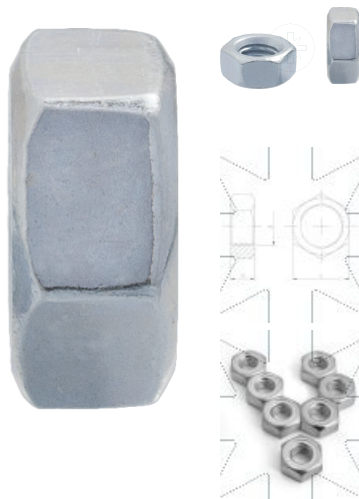
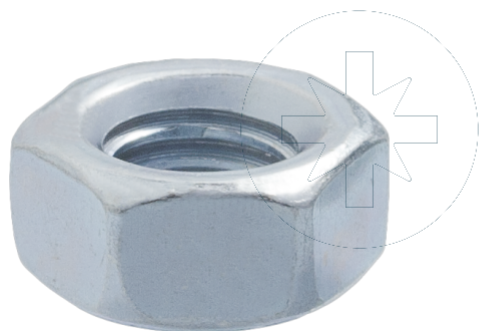

SEND THE INQUIRY

+48 58 55 40 410

## Standards:

DIN 934  
~ISO 4032  
PN-M 82144

Class (standard):



Coating (standard):



Coating (special order):

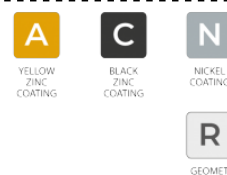

## Dimensions

Material index	d	m [mm]	s [mm]	Mechanical properties class	Type of coating
1501040BD934T	M4	3.2	7.0	6	B (White zinc coating)