

15.11 T - nut
NPM

SEND THE INQUIRY

+48 58 55 40 410

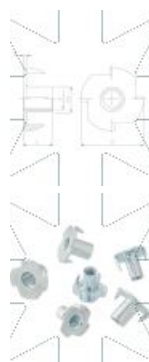
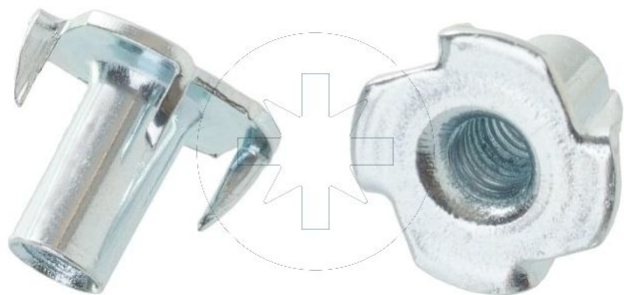

Coating (standard):

B

WHITE
ZINC
COATING

Coating (special order):

A

YELLOW
ZINC
COATING

C

BLACK
ZINC
COATING

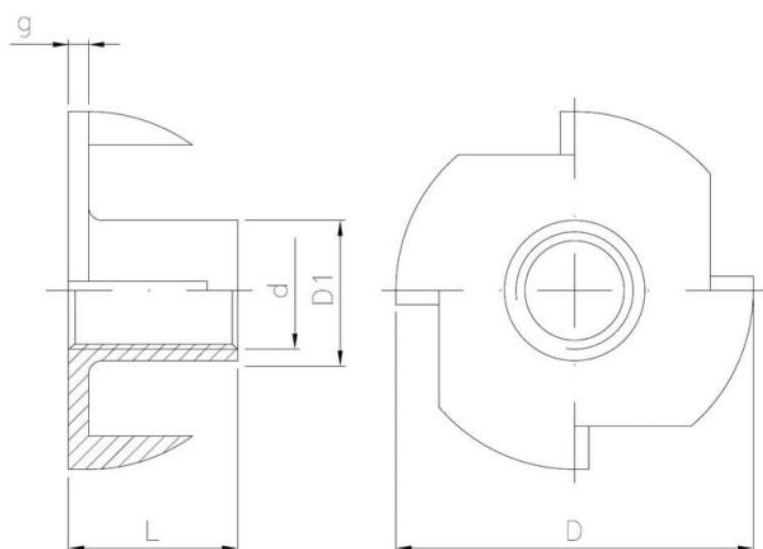

Dimensions

Material index	d	L [mm]	D [mm]	D1 [mm]	g [mm]	Type of coating
1511080015BT	M8	15.0	22.2	9.0	1.5	B (White zinc coating)