

15.15
NRM

Insert nut with hexagonal socket

SEND THE INQUIRY
+48 58 55 40 410



Coating (standard):



WHITE
ZINC
COATING



RAW
PRODUCT

Coating (special order):



YELLOW
ZINC
COATING



BLACK
ZINC
COATING

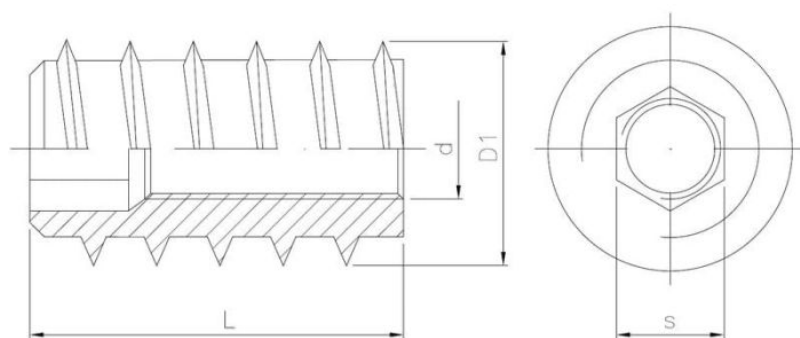

Dimensions

Material index	d	L [mm]	D [mm]	s [mm]	Type of coating
1515080140018BT	M8	18	14.0	8.0	B (White zinc coating)